

EIGENSCHAFTEN

- Mit zwei fest montierten Rädern ausgestattet, leicht zu bewegen.
- Gitter problemlos austauschbar.
- Kein elektrischer Anschluss erforderlich.
- Magnetischer Mehlbehälter.
- Geringer Platzbedarf.
- Platzsparende Unterbringung für 4 Gitter.
- Mit Teigteilwanne und 2 Gitter ausgestattet.
- Manuelles Teilen und Formen des Teiges.

CARACTERÍSTICAS

- Montado sobre dos ruedas fijas, fácil de mover.
- Parrillas de corte fácilmente intercambiables.
- No es necesaria conexión eléctrica.
- Caja magnética para la harina.
- Ocupa poco espacio.
- Almacenaje de 4 parrillas.
- Equipado con un contenedor divisor y 2 rejillas de corte.
- Cortado y moldeado manual de la pasta.







CARATTERISTICHE

- Facile da spostare grazie alle due rotelle fisse.
- Griglie facilmente intercambiabili.
- Non richiede collegamenti elettrici.
- Cestino magnetica per farina.
- Ingombro ridotto.
- Spazio per 4 griglie.
- Dotata di vasca di divisione e 2 griglie.
- Divisione e formatura manuali.



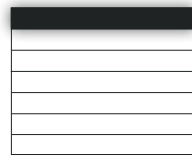
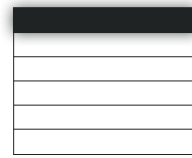







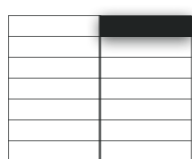
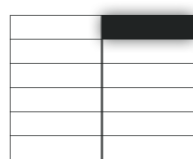

KUNSTSTOFFGITTER | PARRILLA EN PLÁSTICO | GRIGLIA IN PLASTICA

Einfache Teilung | división simple | Divisione semplice

			
			
MSG101001P	MSG080801P	MSG070107P	MSG060106P
10 (10 x 1)	8 (8 x 1)	7 (1 x 7)	6 (1 x 6)
180 - 500 gr	225 - 625 gr	255 - 710 gr	300 - 830 gr
30 x 334 mm	41 x 334 mm	454 x 47 mm	454 x 54 mm

Doppelte Teilung | Doble división | Divisione doppia



					
					
MSG201002P	MSG160802P	MSG140207P	MSG120206P	MSG100502P	MSG080402P
20 (10 x 2)	16 (8 x 2)	14 (2 x 7)	12 (2 x 6)	10 (5 x 2)	8 (4 x 2)
90 - 250 gr	110 - 310 gr	125 - 355 gr	150 - 415 gr	180 - 500 gr	225 - 625 gr
30 x 160 mm	41 x 160 mm	224 x 45 mm	224 x 54 mm	155 x 80 mm	155 x 105 mm

Gitter mit profilierten Messern:
 Profiliertes Messer aus POM-Kunststoff, für Nahrungsmittel geeignet, für ein ausgezeichnetes verschließen des Teiges bei der Teigteilung.

Parrillas con cuchillas perfiladas:
 Cuchillas perfiladas de polioximetileno, aptas para uso comestibles, para una soldadura perfecta de la masa mientras la división.

Griglie con lame sagomate:
 Lame sagomate di polioximetilene, idonee per l'uso di alimenti, per una saldatura perfetta della pasta nella divisione.

GITTER AUS EDELSTAHL | PARRILLA EN ACERO INOX | GRIGLIA IN ACCIAIO INOSSIDABILE





MSG060601

6 (6 x 1)

300 - 1000 gr

73 x 334 mm





MSG080801

8 (8 x 1)

225 - 750 gr

54 x 334mm





MSG101001

10 (10 x 1)

180 - 600 gr

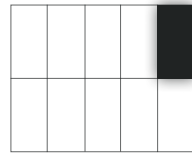
42 x 334 mm





MSG100502

10 (5 x 2)

180 - 600 gr

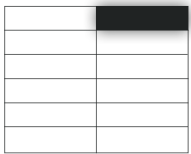
88 x 160 mm





MSG120206

12 (2 x 6)

150 - 500 gr

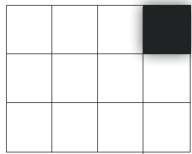
224 x 53 mm





MSG120403

12 (4 x 3)

150 - 500 gr

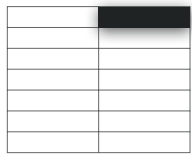
115 x 108 mm





MSG140207

14 (2 x 7)

125 - 425 gr

224 x 47 mm





MSG200504

20 (5 x 4)

90 - 295 gr

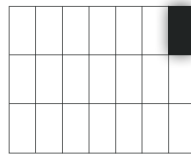
87 x 80 mm





MSG210703

21 (7 x 3)

85 - 285 gr

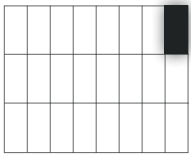
62 x 108 mm





MSG240803

24 (8 x 3)

75 - 250 gr

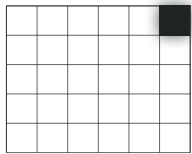
57 x 108 mm





MSG300605

30 (6 x 5)

60 - 200 gr

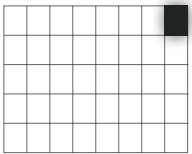
73 x 64 mm





MSG400805

40 (8 x 5)

45 - 125 gr

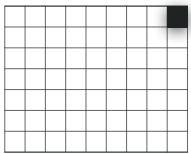
54 x 64 mm





MSG630907

63 (9 x 7)

25 - 63 gr

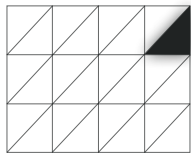
47 x 45 mm

MSG240403/2

24 (4 x 3) x 2

75 - 165 gr

115 x 108 x 150 mm

Gewicht und Abmessungen können je nach Teigart variieren. ■ El peso y las dimensiones pueden variar según el tipo de masa. ■ Peso e dimensioni possono variare a seconda del tipo di impasto.



Gitter problemlos austauschbar.

Parrilla de corte fácilmente intercambiables.

Griglie facilmente intercambiabili.

Magnetischer Mehlbehälter.
Contenedor magnético para la harina.
Contenitore magnetico per farina.

Herausziehbare Halterung für die Teigteilwanne.
Apoyo extraíble para el contenedor de división.
Supporto estraibile per il cestello di divisione.

Pressplatte ebenfalls erhältlich.
También está disponible una placa de prensado.
Disponibile anche la piastra di pressione.

Unterbringung für 4 Gitter.
Almacenaje para 4 parrillas.
Spazio per 4 griglie.

Option: Blechwagen

Opción: carro para contenedores

Opzione: carrello per teglie

Teigwanne | Cubetas | Recipienti **14**

Deckel | Tapas | Coperchi **14**

Kapazität | Capacidad | Capacità **9,8 L (5 - 6 kg)**



SEITENANSICHT | PERFIL | VISTA LATERALE

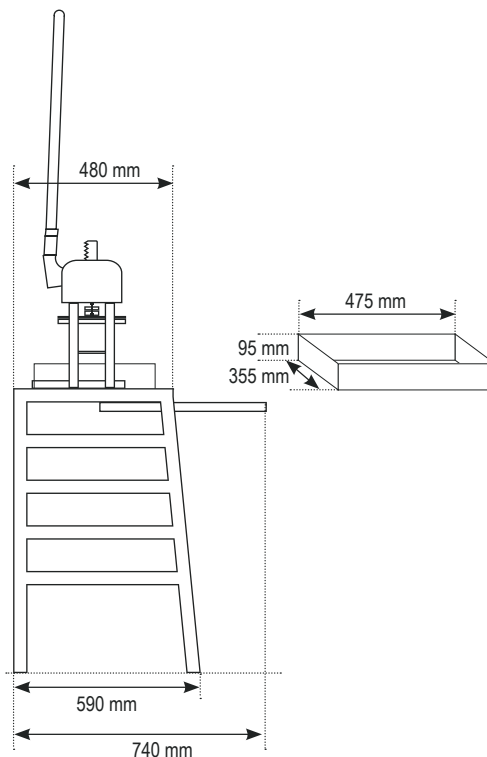

VORDERANSICHT | ALZADO | VISTA FRONTALE

